

# Instruction manual niche

OD-5520

Material: Stainless steel

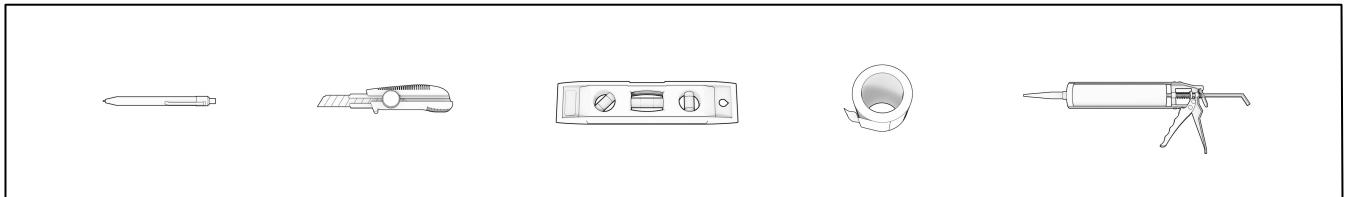

The following installation details are applicable for existing wall before tiling and do not cover every possible situation. Always consult with a licenced professional during preparation and installation.

If you are using a newly constructed wall, start the installation from step 3.

If the distance between the wall studs are greater than the niche, add a frame around the niche to accommodate it. Professional advice may be needed.

## Installation of the niche

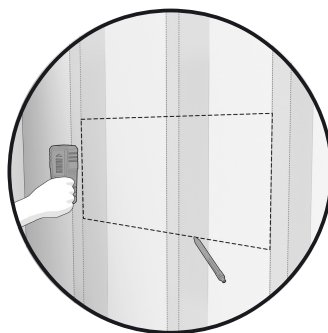

1. Locate and mark the center lines of the adjacent wall studs using a stud finder. Draw a level line between the two wall studs at the desired height to insert the niche.

# Installation of the niche

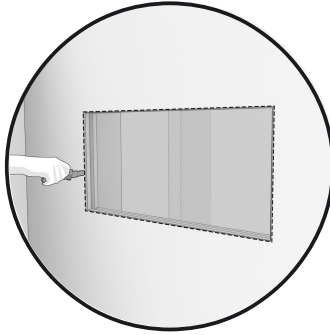

2. Trace the cutting line with a pencil, above the center line, cut a cavity in the wall panel along the drawn line. Make sure that the top and bottom lines are level.

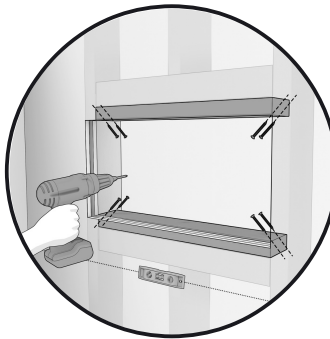

3. Level and secure the upper and lower support frame to the adjacent vertical studs.

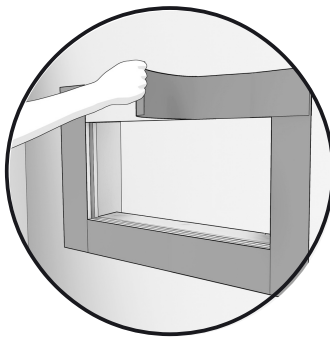

4. Install the waterproofing membrane to seal the support structure and the cavity (not included).

# Installation of the niche

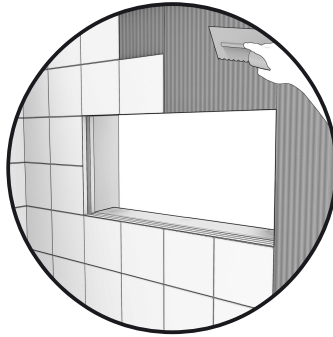

5. Apply your installation material and fix your tiles, marbles or stones directly on the shower wall. It is preferable that the tiles are symmetrical around the support structure.

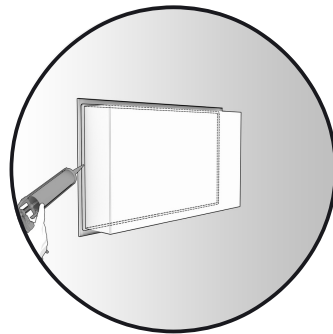

6. Apply a necessary layer of silicone around the back periphery of the flange of the niche to ensure watertightness.



7. Insert the niche into the cavity. Press firmly on the flange and make sure that the niche is in place. It is recommended to seal the space between the flange and the tile.

# Installation instruction



8. Add adhesive tape to hold the niche in place until the silicone has hardened.



**Wait 24 hours before using the shower.**

**Please be sure to read the manual carefully before installation.**

## **MAINTENANCE**

Wipe the surface with a soft cloth after each use. Use mild cleaning products. For tougher stains, use a mildly abrasive cream cleaner. Never use petroleum-based products for cleaning, such as paint thinners or other solvents, as they can damage the solid surface.

## **LIMITED GUARANTEE**

Odass offers a guarantee 5-year limited\* term on all finishes of niches and washbasins from the Nano Tech collection in stainless steel, 2 years on the Nano protection of niches and sinks and 5 years his electrical components of niches against all faults manufacturing in normal conditions of use and maintenance from the date of purchase original of the product by the owner/user, the contractor or the constructor.