

Washbasin instruction manual

OD-5035

Material: Stainless steel

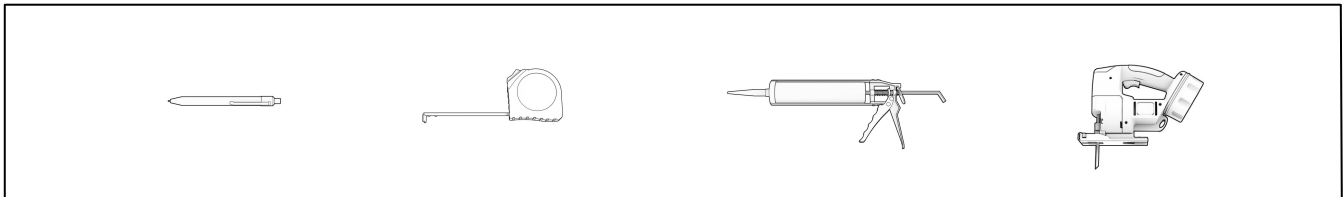

Read the instructions carefully before you start to install.

Comply with building and plumbing codes.

WARNING

Handle with care. Product may break or cause injury if not handled carefully.

Tighten the drain carefully to not damage the sink.

Installation of the washbasin

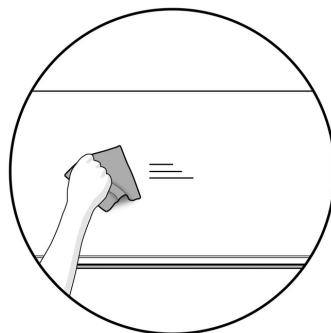

1. Thoroughly clean the surface of the counter to be drilled.

Installation of the washbasin

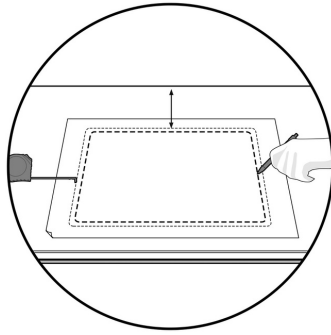

2. Trace the dimensions of the holes to be drilled in the counter. Measure the space required for the installation of the drain and faucet.

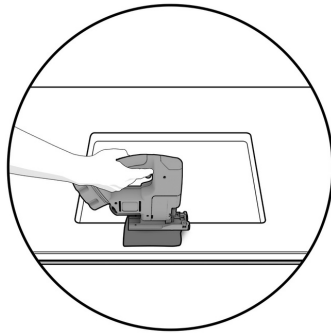

3. Cut the opening using a jigsaw. Use a soft cloth between the surface of the counter and the saw to not damage or scratch the counter.

Make sure you have the necessary space under the counter for the drain and the piping.

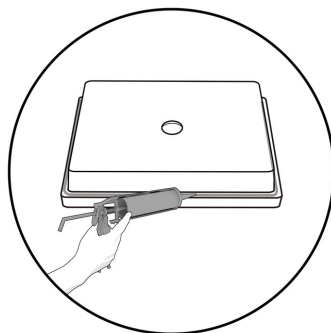

4. Apply plumber's putty along the inside edge under the washbasin. Place the washbasin in the desired location. Press firmly to spread the sealant and immediately wipe off the excess with a damp cloth.

Installation of the washbasin

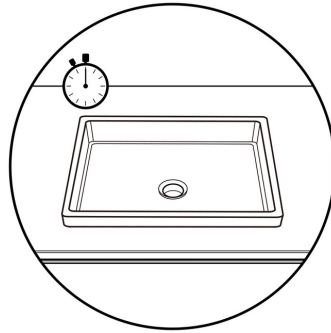

5. Let the putty dry for a few hours before connecting the water supply and drain pipes.

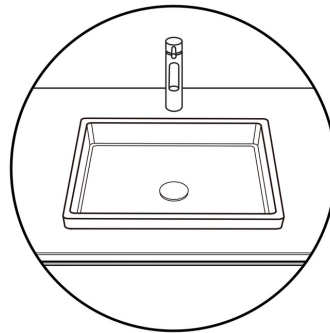

6. Install the faucet and drain following the instructions provided. Tighten the drain carefully to the washbasin to avoid breaking the latter.

MAINTENANCE

Wipe the surface with a soft cloth after each use. Use mild cleaning products. For tougher stains, use a mildly abrasive cream cleaner. Never use petroleum-based products for cleaning, such as paint thinners or other solvents, as they can damage the solid surface.

LIMITED GUARANTEE

Odass offers a guarantee 5-year limited* term on all finishes of niches and washbasins from the Nano Tech collection in stainless steel, 2 years on the Nano protection of niches and sinks and 5 years his electrical components of niches against all faults manufacturing in normal conditions of use and maintenance from the date of purchaseoriginal of the product by the owner/user, the contractor or the constructor.